

BEST USER AGE: 2-5

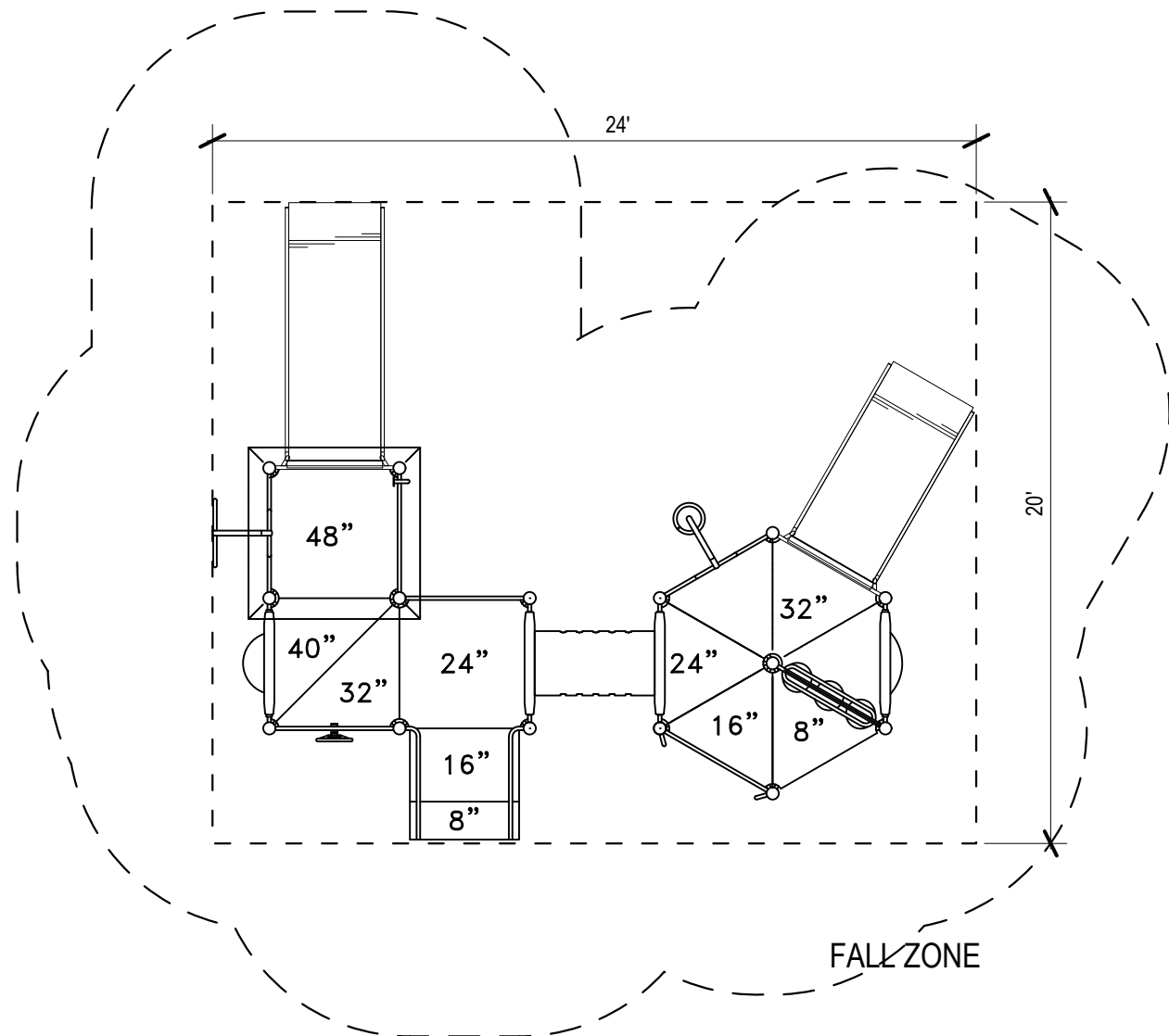

New York City Housing Authority
Capital Projects Division
Design Department
90 Church Street, 10th Floor
New York, NY 10007

Title:

**COLUMBIA CASCADE
MODEL NO. 9839-M
PIPELINE PLAY STRUCTURE**

Contract Name:

GROUNDS REQUIREMENT

Contract No.

GD XXXXXXX

Drawn by:

G. SOUKAS

Checked by:

K. MARSHAL

Scale:

Not to Scale

Date:

January 2017

Drawing No.

PYC- 16